

Installation

Air Switch

Description: The LX150 is an easily installed air actuated On/Off control for an electrical device up to 1HP, 120V. Simply plug the LX150 into any standard electrical outlet and plug the appliance into the receptacle provided in the LX150. The appliance can be activated and deactivated by depressing an air button mounted up to 15' away. Please Note: A 6' roll of tubing is supplied.



Installation Instructions (for Button Packaged Units): Determine location of air button, drill or knock out 1-3/8" hole. Determine and attach the desired trim kit finish. Install button by placing through the hole and hand tightening the nut underneath. Secure it snug enough to establish a watertight seal but do not over-tighten to damage the plastic. Silicone (Plastic ABS compatible) may be required in order to bond to some surfaces. Attach the air hose to the spout located at the bottom of the button. Cut the hose (or coil the hose loosely) to the length needed to reach the control box. The maximum effective tube distance is 15'. Please Note: A 6' roll of tubing is supplied. Plug the hose into the spout located on the bottom of the control box. Plug unit into a UL approved, grounded three pronged outlet.

Garbage Disposal Applications:

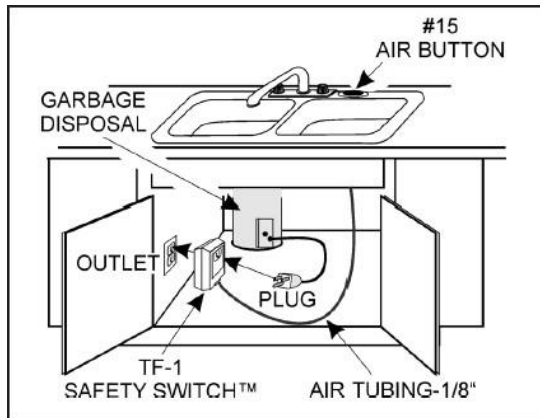

- Eliminates need for an electrical wall switch
- Simplifies first time garbage disposal installations
- Operates on a 120V household wall receptacle

Dimensions:

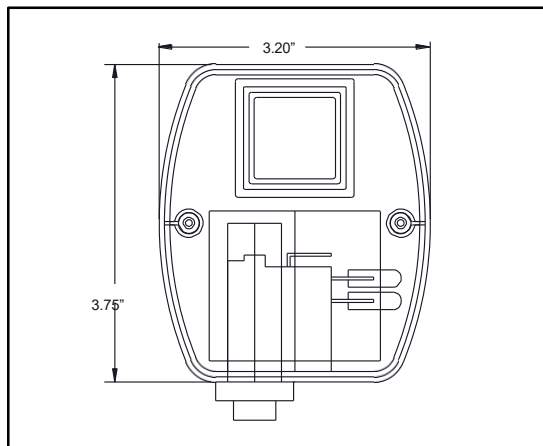

NOTE: Ground connections are not shown and vary with installations.

CAUTION: USE COPPER CONDUCTORS ONLY. Do not lubricate relays. All controls must be installed by a licensed electrician according to these instructions.



Installation

IMPORTANT SAFETY INSTRUCTIONS READ AND FOLLOW ALL INSTRUCTIONS

1. A pressure wire connector is provided on metallic enclosures to permit connections of a minimum No. 8 AWG solid copper bonding conductor between any metal equipment, metal enclosures of electrical equipment, metal water pipe, or conduit within 5 feet (1.5 m) of the unit as needed to comply with local requirements. Polymeric enclosures are supplied with an internal equipment ground bar.
2. THIS CONTROL MUST BE FACTORY INSTALLED OR INSTALLED BY A LICENSED ELECTRICIAN ACCORDING TO STATE, NATIONAL, AND LOCAL ELECTRICAL CODE AND THE INSTRUCTIONS.
3. Use copper conductors only.
4. DANGER - To reduce the risk of injury do not permit children to use this product unless they are closely supervised at all times.
5. Install to provide drainage of compartment for electrical components.
6. A ground-fault circuit interrupter (GFCI) designated line is to be installed in accordance with the National Electrical Code, the Canadian Electrical Code and all local codes in effect at the time of installation. When unit is provided with a GFCI, the GFCI must be tested monthly. To conduct the test the unit must be operating. Push the test button. The unit should stop operating and the reset button should appear. Push the reset button. The unit should now operate normally. If the interrupter fails to operate in this manner, there is a ground current flowing, indicating the possibility of electric shock. Disconnect the power until the fault has been corrected.
7. The electrical supply for this product must include a suitably rated switch or circuit breaker to open all ungrounded supply conductors to comply with Section 422-20 of the National Electrical Code, ANSI/NFPA 70-1987. The disconnect must be readily accessible to the tub occupant but installed at least 5 feet (1.5m) from tub water.
8. No electrical appliance may be placed within a 5 foot reach path from the water's edge.
9. Use only non-conductive tubing to connect any air actuator.
10. Valve must be inaccessible to tub occupant and installed at least 5 feet away from the inside walls of the tub.

READ AND SAVE THESE INSTRUCTIONS

